

REPRINTED ARTICLE

Articles published elsewhere which are considered by the Editorial Board to be of special interest are with permission reprinted in full, or in condensed form, or in free translation.

HLA Class II Immune Response and Suppression Genes in Leprosy*

The dispute between hereditarians and contagionists. In 1841, Simpson stated that "few facts in the history of tubercular leprosy seem to be more universally admitted by all writers on the disease, both ancient and modern, than the transmission of the predisposition to it from parents to offspring" (cited from ¹). This statement seemed to be severely challenged by Armauer Hansen's discovery of the leprosy bacillus, *Mycobacterium leprae*, and his—by then—revolutionary conclusion that "a bacillary disease cannot be inherited."² Obviously, from Hansen's observation it was clear that "the contagionist view" was correct in the sense that an infectious disease can develop only after infection with the causative microorganism. It is thus not surprising that it took nearly a century until "the hereditarians" had recovered from this blow and a certain role for genetic factors in leprosy became reappraised. Spickett proposed in 1962 that the form of leprosy was determined by genetic factors,³ and Bei-

guelman reported an increased concordance for leprosy type within families.⁴ Chakravarti and Vogel published an important twin study from which they concluded that both the risk of developing leprosy as well as the type of leprosy which develops after infection are strongly influenced by genetic factors.⁵ Although this study almost certainly suffered from a considerable ascertainment bias, nevertheless, together with other studies,^{6,7} it gave a significant impetus toward the study of immunogenetics in leprosy. The obvious challenge became to determine the identity and mode of action of the genetic factors involved in the development of leprosy (type).

The discovery of MHC Ir and Is genes. What was at first hand a completely unrelated area of research to leprosy was the discovery of tissue transplantation antigens in animals and subsequently in man.⁸ These antigens were found to induce rejection of tissue grafts that were histoincompatible with the recipient. Soon, a series of different

* This paper was presented during the IV European Leprosy Symposium on Leprosy Research and will be published in the proceedings (Health Cooperation Papers No. 1, 1987, in press). We reprint it here with the kind permission of Prof. Enrico Nunzi, Editor, Health Cooperation Papers, and the authors.

¹ Fine, P. E. M. Immunogenetics of susceptibility to leprosy, tuberculosis and leishmaniasis; an epidemiological perspective. *Int. J. Lepr.* **49** (1981) 437–454.

² Hansen, G. A. Heredity of leprosy. *Arch. Dermat. Syph.* **110** (1886) 225–232.

³ Spickett, S. G. Genetics and the epidemiology of leprosy. II. The form of leprosy. *Lepr. Rev.* **33** (1962) 173–181.

⁴ Beiguelman, B. An appraisal of genetic studies in leprosy. *Acta Genet. Med. Gemellol.* **21** (1972) 21–52.

⁵ Chakravarti, M. R. and Vogel, F. A twin study on leprosy. In: *Topics in Human Genetics, Vol. II*. Becker, P. E., et al., eds. Stuttgart: Georg Thieme Publishers, 1973, pp. 1–123.

⁶ Smith, D. G. The genetic hypothesis for susceptibility to lepromatous leprosy. *Hum. Genet.* **50** (1979) 163–177.

⁷ Serjeantson, S., Wilson, S. R. and Keats, B. J. The genetics of leprosy. *Ann. Hum. Biol.* **6** (1979) 375–393.

⁸ Götze D., ed. *The Organization of the Major Histocompatibility System in Man and Animals*. New York: Springer Verlag, 1977.

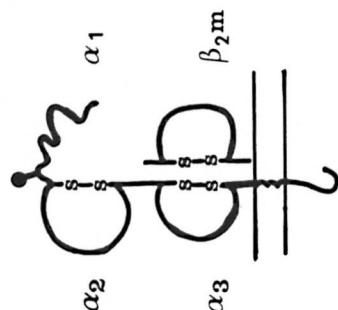
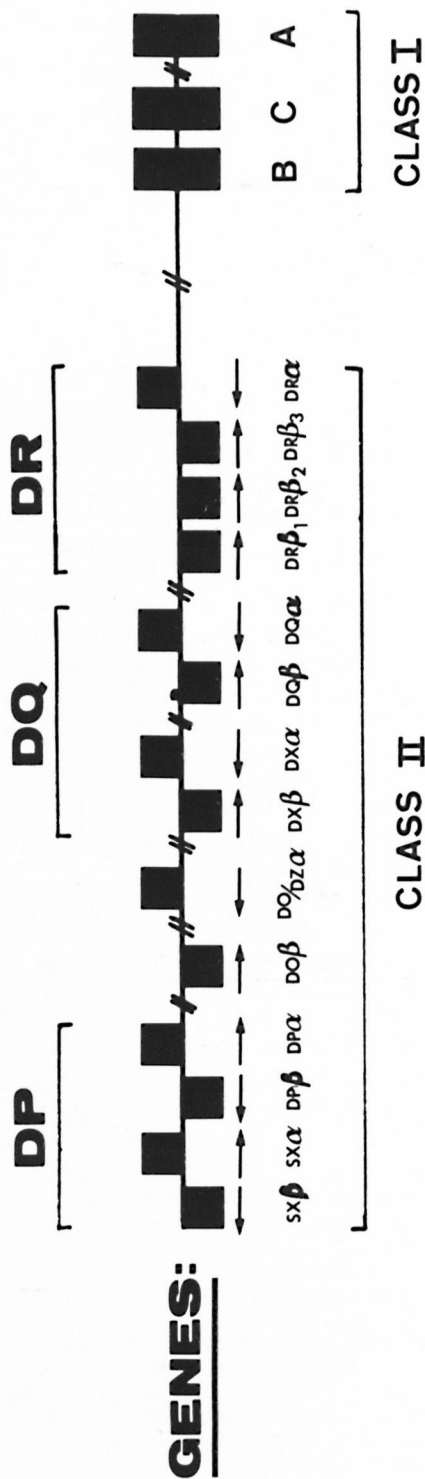

**antigen presentation
to cytotoxic T cells**

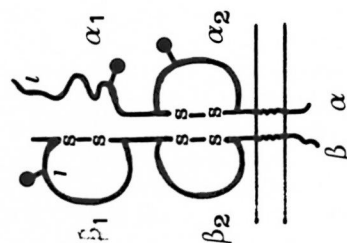

**antigen presentation
to regulatory T cells**

PRODUCTS:

FUNCTION:

FIG. 1. Schematic representation of the HLA system.

loci with multiple alleles were discovered. Since these loci appeared to be tightly linked to each other as well as remarkably homologous between different mammalian species, this genetic complex was designated the major histocompatibility complex (MHC). The human MHC is known as the HLA system; the murine MHC is referred to as H-2.

A schematic picture of the HLA complex is shown in Figure 1. There are two major classes of genes and gene products, namely, class I (A, B, C) and class II (DP, DQ, DR). These genes—and their products—are found in many varieties, or alleles, in humans and in animals. For example, there are more than 20 HLA-A alleles, more than 40 HLA-B ones, and so forth. Class I molecules are membrane glycoproteins which are composed of a heavy or α chain ($M_r = 44K$) and a noncovalently associated light chain, β_2 microglobulin ($M_r = 12K$). These molecules are expressed by nearly all nucleated cells. Class II molecules are expressed as heterodimeric glycoproteins, consisting of a heavy (α ; $M_r = 33\text{--}35K$) and a light (β ; $M_r = 26\text{--}29K$) chain joined on the cell surface by noncovalent bonds. These molecules are usually expressed only by immunocompetent cells, such as antigen-presenting cells (e.g., monocytes, macrophages, dendritic cells, Langerhans' cells), B cells, and activated T cells. The genomic organization of the class II region is more complex than that of the HLA-A, HLA-B, and HLA-C region. At least four gene clusters have been found so far, namely, DP, DZ/DO, DQ, and DR. For DP, DQ, and DR, several α and/or β genes have been defined. Some of these genes are pseudogenes and, therefore, not expressed. The number of potential α - β combinations even further increases the complexity of this region at the product level (for a review on MHC class I and class II, see ⁹).

The large number of multi-allelic loci gives the HLA system—and the MHC in general—its unique polymorphism. This polymorphism exists in nearly all mammalian species studied so far and, therefore, sug-

gests an important biological role for the MHC. In 1954, the first and intriguing clue as to such a function of the MHC became apparent. Lilly, *et al.* showed that resistance to Gross virus-induced leukemia was controlled by genes linked to the H-2 system.¹⁰ Thus, it was suggested that a major biological role for genes within the MHC may be their influence on susceptibility and resistance to (infectious) diseases. In the same period, Levine, *et al.*,¹¹ McDevitt and Chinitz,¹² and Benacerraf and McDevitt¹³ demonstrated that the MHC controlled immune responsiveness to T-cell dependent antigens. Since then, an overwhelming body of evidence has shown that MHC genes and products control immune responsiveness to a large array of antigens and pathogens (reviewed in ^{14,15}). In other words, the MHC contains so-called immune-response (Ir) c.q. immune-suppression (Is) genes.^{14,15} These Ir/Is genes (Fig. 2[a]) code for Ir/Is gene products (Fig. 2[b]) which have a role in the immune response and may differ between different individuals because of their polymorphism. These differences lead to differences in immune reactivity (Fig. 2[c]) which, in turn, can cause differential susceptibility to or expression of disease (Fig. 2[d]). Understanding the way in which MHC Ir/Is genes exert their influence may lead to preventive and therapeutical applications (see below).

How do MHC Ir and Is genes influence immune responsiveness? Unlike B cells, T cells do not respond to free antigen, but only to antigen that is presented to the T cell in

¹⁰ Lilly, F., Boyse, E. A. and Old, L. J. Genetic basis for susceptibility to viral leukaemogenesis. *Lancet* **2** (1964) 1207–1209.

¹¹ Levine, B. B., Ojeda, A. and Benacerraf, B. Studies on artificial antigens. III. The genetic control of the immune response to hapten-poly-L-lysine conjugates in guinea pigs. *J. Exp. Med.* **118** (1963) 953–957.

¹² McDevitt, H. O. and Chinitz, A. Genetic control of antibody response: relationship between immune response and histocompatibility (H-2) type. *Science* **163** (1969) 1207–1208.

¹³ Benacerraf, B. and McDevitt, H. O. The histocompatibility-linked immune response genes. *Science* **175** (1972) 273–279.

¹⁴ Benacerraf, B. Role of MHC gene products in immune regulation. *Science* **212** (1981) 1229–1238.

¹⁵ Schwartz, R. H. Immune response (Ir) genes of the murine major histocompatibility complex. *Adv. Immunol.* **38** (1986) 31–201 (470 refs).

⁹ Möller, G., ed. Molecular genetics of class I and II MHC antigens. I and II. *Immunol. Rev.* **84** (1985) 7–143 and **85** (1985) 5–168.

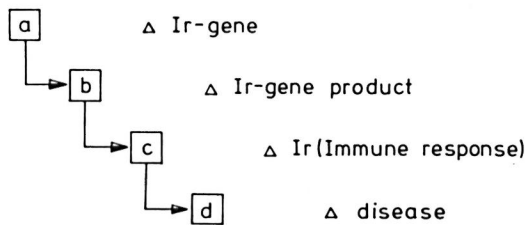

FIG. 2. The immunogenetic approach to disease.

association with a self MHC molecule. This MHC restriction of T-cell activation was first discovered in animal models: murine cytotoxic T cells (Tc) which specifically killed autologous target cells infected with lymphocytic choriomeningitis virus could only lyse similarly infected allogeneic target cells if the latter expressed the same H-2 haplotype.¹⁶ In analogy, histocompatible macrophages and (helper) T lymphocytes (Th) were required in order for antigen to induce T-lymphocyte proliferation.¹⁷

As a rule, Tc are restricted by self MHC class I molecules; whereas Th are restricted by self MHC class II molecules. Th cells mediate delayed-type hypersensitivity (DTH) and protective immunity against intracellular microorganisms such as mycobacteria¹⁸ and, in addition, provide essential help for Tc and B cells. Thus, Th lymphocytes initiate and regulate immune responses, and therefore have a central position in the immune network.

The property of MHC molecules to restrict and regulate T-cell activation explains the phenomenon of MHC Ir/Is genes:^{14, 15} because of the polymorphism of HLA molecules, interindividual differences will exist in the way in which HLA molecules together with a specific antigen can "cooperate" to activate T cells. In certain combinations of an antigen and a MHC molecule, only poor or even no T-cell activation will occur. Such

an individual will, thus, be a low- or non-responder to that specific antigen as a consequence of his/her phenotype, and may be prone to develop disease when the antigen unfortunately happens to be a pathogenic microorganism. It has been established that MHC Ir/Is genes act at the level of T-cell antigen-presenting cell interaction.^{14, 15} Different models have been proposed to account for Ir/Is gene phenomena, namely: a) differences in the available or selected T-cell antigen-MHC receptor repertoire, b) differences in the capacity of MHC molecules to associate directly with antigen in order to create an immunogenic complex for T cells, and c) (for Is genes) the preferential induction of suppressor T cells (Ts) rather than Th cells (reviewed in ^{14, 15}). At present, it seems that these models are not *a priori* mutually exclusive and that—dependent on the antigen and MHC involved—one or another mechanism may predominate.

T-cell-mediated immunity in leprosy. Perhaps the most intriguing feature of leprosy is the striking interindividual variability in clinical symptoms that will appear in the course of the disease. This variability in clinical manifestations closely parallels the T-cell-mediated immune response which is mounted by the host against *M. leprae*.¹⁹ At one pole of the disease spectrum are the "high resistant" or polar tuberculoid (TT) leprosy patients. These patients display both acquired immunity and DTH against *M. leprae* which are generally assumed to be conferred by Th cells. At the other pole are lepromatous leprosy (LL) patients showing a *M. leprae*-specific Th unresponsiveness, presumably as a consequence of *M. leprae*-reactive Ts cells.¹⁹ In between these two poles, variable degrees of tuberculoid and lepromatous features may be seen in borderline patients.¹⁹

The unique opportunity in leprosy to study the immune mechanisms of the host-parasite interaction renders it a "model disease which provides essential information on the importance of immune reactions in several chronic infectious diseases."²⁰ It may

¹⁶ Zinkernagel, R. M. and Doherty, P. C. Restriction of *in vitro* T cell mediated cytotoxicity in lymphocytic choriomeningitis within a syngeneic or semiallogeneic system. *Nature* **248** (1974) 701–702.

¹⁷ Rosenthal, A. S. and Shevach, E. M. Function of macrophages in antigen recognition by guinea pig T-lymphocytes. I. Requirements for histocompatible macrophages and lymphocytes. *J. Exp. Med.* **138** (1973) 1194–1212.

¹⁸ Hahn, H. and Kaufmann, S. H. E. The role of cell-mediated immunity in bacterial infections. *Rev. Infect. Dis.* **3** (1981) 1221–1250.

¹⁹ Bloom, B. R. and Godal, T. Selective primary health care: strategies for control of disease in the developing world. V. Leprosy. *Rev. Infect. Dis.* **5** (1983) 765–780.

²⁰ Harboe, M. and Closs, O. Immunological aspects

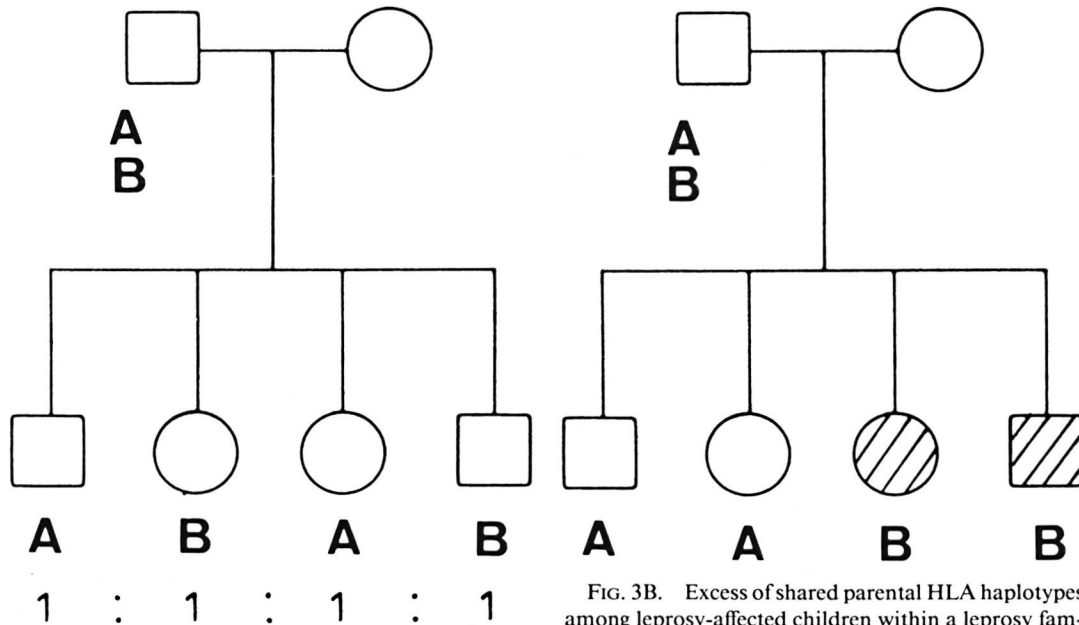

FIG. 3A. Random inheritance of parental HLA haplotypes A and B in a healthy family.

FIG. 3B. Excess of shared parental HLA haplotypes among leprosy-affected children within a leprosy family.

also be a model for other chronic diseases, whether infectious or noninfectious, such as rheumatoid arthritis (see below).

Why study HLA and leprosy? The evidence for genetic influences on the development of leprosy (type), the apparently immunological nature of the disease as well as the evidence for MHC Ir-gene-controlled resistance and susceptibility to (infectious) diseases in animal studies provided the basis for the genetic studies on HLA and leprosy. Several of these studies will be discussed briefly in the next section.

The finding that HLA class II molecules restrict and regulate Th cells—and maybe Ts cell responsiveness—and the possibility of isolating *M. leprae*-reactive Th and Ts cells from leprosy patients led to a series of *in vitro* studies. Recently, the availability of well-defined *M. leprae* antigens²¹ has enhanced the precision of those analyses. The

aim of these experiments has been to define the *M. leprae* antigenic determinants as well as the HLA class II Ir/Is gene products that are recognized by Th cells and presumably Ts cells in tuberculoid and lepromatous leprosy patients. These studies will be discussed in the third section. The last section will be devoted to preventive or therapeutic applications of the results of our studies, both in leprosy as well as in other HLA-associated diseases.

HLA and leprosy: genetic studies

There are basically two ways to look for a possible relationship of HLA with disease susceptibility: family studies and population studies. One type of family study is the twin study discussed above.⁵ A more current type of family study is segregation and linkage analysis. Several of these latter studies as well as a number of population studies will be discussed briefly in this section.

HLA segregation and linkage studies in multi-case leprosy families. *Nonrandom HLA haplotype segregation to leprosy-affected children.* In families with both leprosy-affected and healthy sibs, the segregation of complete HLA haplotypes from each parent to those sibs can be studied. This is illustrated schematically in Figure 3. If HLA-linked genes have no influence on the de-

of leprosy. In: *Immunology 1980*. Fougereau, M. and Dausset, J., eds. London: Academic Press, 1980, pp. 1231-1243.

²¹ Young, R. A., Mehra, V., Sweetser, D., Buchanan, T. M., Clark-Curtiss, J., Davis, R. W. and Bloom, B. R. Genes for the major protein antigens of the leprosy parasite *Mycobacterium leprae*. *Nature* **316** (1985) 450-452.

velopment of leprosy (type), one would expect a random segregation (distribution) of parental haplotypes among both diseased and healthy sibs, as depicted in Figure 3A. If, however, HLA-linked genes predispose to leprosy (type), one would expect a non-random HLA haplotype segregation, leading to an excess of shared haplotypes among children suffering from (a certain type of) leprosy²² (Fig. 3B). In Table 1, the combined HLA segregation data from more than 120 leprosy families from different parts of the world are summarized^{23, 24} (for detailed reviews on HLA-family studies in leprosy see 1, 23, 25, 26). These results clearly show that there is a significant excess of shared parental HLA haplotypes among both TT and BL-LL affected sibs. This indicates that susceptibility to both TT and BL-LL leprosy is controlled, at least partly, by HLA-linked genes. In addition, this same analysis shows that this nonrandom HLA haplotype segregation is confined to affected children only, and is perfectly random in healthy children. If HLA-linked genes conferred susceptibility to leprosy per se, one would have expected a preferential—and thus nonrandom—segregation of parental haplotypes lacking such HLA-linked susceptibility genes (“healthy haplotypes”) to healthy sibs. Thus, although HLA-linked genes play an important role in the development of TT and BL-LL leprosy, those genes do not simply confer susceptibility to the disease but apparently act in a different way. A similar analysis, namely, the determination of the presence among healthy siblings of those HLA haplotypes which are shared more often among all leprosy patients in that sibship (i.e., the “leprosy haplotypes”), also showed no deviation from random segre-

gation for these haplotypes among healthy sibs.²³ Thus, it is concluded that susceptibility to leprosy per se seems not to be determined by HLA-linked genes, but that the type of leprosy which develops in individuals who are susceptible to leprosy is, at least in part, determined by such genes. Most probably, susceptibility to leprosy per se is influenced by both environmental and non-HLA-encoded genetic factors, in analogy with experimental mouse models where innate resistance toward various intracellular microorganisms, including mycobacteria, is controlled by a single non-H-2-linked gene.²⁷ The H-2 type, then, influences the type of acquired immune response after infection.²⁸

HLA haplotypes carrying specific class II markers. In several leprosy family studies, a preferential inheritance of HLA haplotypes carrying a certain class II specificity was observed.²³ In a Venezuelan family study, a significant deficit of DR3+ haplotypes was observed among BL-LL children; whereas DR3+ haplotypes tended to be inherited more often by TT children. The opposite was true for DQw1²⁹ (Table 2). This latter observation was also made in China (Table 3) (R. R. P. de Vries, unpublished observations;³⁰), and was confirmed by a worldwide collaborative study showing that lepromin unresponsiveness *in vivo* was determined at least in part by a HLA-DQw1-linked gene.³¹

²² de Vries, R. R. P., Lai-A-Fat, R. F. M., Nyenhuis, L. E. and van Rood, J. J. HLA-linked genetic control of host response to *Mycobacterium leprae*. *Lancet* **2** (1976) 1328–1330.

²³ van Eden, W. and de Vries, R. R. P. Occasional review-HLA and leprosy: a re-evaluation. *Lepr. Rev.* **55** (1984) 89–104.

²⁴ de Vries, R. R. P., van Eden, W. and Ottenhoff, T. H. M. HLA class II immune response genes and products in leprosy. *Progr. Allergy* **36** (1985) 95–113.

²⁵ de Vries, R. R. P., van Eden, W. and van Rood, J. J. 1981. HLA-linked control of the course of *M. leprae* infections. *Lepr. Rev.* **52** Suppl. (1981) 109–119.

²⁶ Serjeantson, S. W. HLA and susceptibility to leprosy. *Immunol. Rev.* **70** (1983) 24–47.

²⁷ Skamene, E., Gross, P., Forget, A., Patel, P. J. and Nesbitt, M. N. Regulation of resistance to leprosy by chromosome 1 locus in the mouse. *Immunogen.* **19** (1984) 117–124.

²⁸ Adu, H. O., Curtis, J. and Turk, J. L. Role of the major histocompatibility complex in resistance and granuloma formation in response to *Mycobacterium lepraemurium* infection. *Infect. Immun.* **49** (1983) 720–725.

²⁹ van Eden, W., Gonzalez, N. M., de Vries, R. R. P., Convit, J. and van Rood, J. J. HLA-linked control of predisposition to lepromatous leprosy. *J. Infect. Dis.* **151** (1985) 9–14.

³⁰ Ottenhoff, T. H. M. and de Vries, R. R. P. HLA-class II immune response genes in leprosy. Studies on the recognition of *Mycobacterium leprae* antigens and class II molecules by cloned human T cells. In: *Developments in Immunology and Haematology*. The Hague: Martinus Nyhoff (in press).

³¹ de Vries, R. R. P., Serjeantson, S. W. and Layrisse, Z. Leprosy. In: *Histocompatibility Testing 1984*. Albert, E. D., Baur, M. P. and Mayr, W. R., eds. Heidelberg: Springer Verlag, 1984, pp. 362–367.

TABLE 1. Children suffering from TT or BL-LL leprosy share HLA haplotypes more frequently than expected.^a

Children	Observed ΣD^b	Expected Σd^c	χ^2	p ^d
TT leprosy ^e	188	139.6	19.36	5×10^{-6}
BL-LL leprosy	89	64.5	10.06	0.0008
Healthy ^f	128	125.8	0.03	NS ^g

^a For method of analysis, see ²².

^b D = observed difference between the number of affected siblings with one and those with the other parental HLA haplotype.

^c d = expected difference in case of random segregation. $\Sigma D > \Sigma d$ indicates an excess of shared HLA haplotypes.

^d p value divided by 2 (one-sided significance test).

^e Offspring from TT parents not included.

^f Healthy sibs older than youngest patient only.

^g NS = not significant.

Population studies. Population studies compare the HLA antigen frequencies in a sample of unrelated patients with those in a well-matched (healthy) control group.³² A significantly increased or decreased frequency of a given HLA antigen among patients indicates an association (positive or negative, respectively) between that particular allele and disease. Such an allele may, therefore, represent a marker for a susceptibility or a resistance gene or be identical to that gene.

Early population studies have observed some associations between HLA-A, HLA-B, and HLA-C antigens and different leprosy types (reviewed in ^{1, 23-26, 30}). However, most of these associations were rather weak, confined to the population tested only and, in some cases, were not reproducible. This lack of convincing associations between HLA class I alleles and leprosy types may imply that the class I antigens are not the right markers for HLA-linked Ir/Is genes.

More convincing and consistent data were found when the HLA class II antigens were studied. A large number of studies observed class II markers for both TT and BL-LL leprosy (reviewed in ^{23-26, 30}). Only two examples will be mentioned here. One study carried out among Surinam negroid leprosy

patients revealed an association of TT with DR3 as compared to healthy controls. The frequency of DR3 was decreased albeit not significantly among BL-LL patients (Table 4) (Ottenhoff, *et al.*, unpublished observations). These findings are in accordance with the Venezuelan family study mentioned earlier.²⁹ Another study in Venezuela showed that DQw1 was a marker for LL leprosy (Table 5)³³—again compatible with

TABLE 2. Inheritance of HLA-DR3 and HLA-DQw1 from, respectively, DR3 and DQw1 heterozygous parents in relation to leprosy status.^a

Children	DR3 in-herited		p	DQw1 in-herited		p
	+	-		+	-	
BL-LL leprosy	2	9	0.03	30	17	0.04
TT leprosy	9	4	NS ^b	6	6	NS
Healthy	12	10	NS	24	26	NS

^a See Table 1 legend.

^b Significant difference between BL-LL and TT children (p = 0.02).

TABLE 3. Preferential inheritance of DQw1 haplotypes by BL-LL and of DQnon1 haplotypes by BT-TT affected children in Chinese multi-case leprosy families.^a

Children	DQw1 inherited		p
	+	-	
BT-TT	2	8	0.003
BL-LL	9	1	
Healthy	10	11	0.03

^a See Table 1 legend.

³² Svegaard, A., Platz, P. and Ryder, L. P. HLA and disease 1982—a survey. *Immunol. Rev.* **70** (1983) 193–218.

³³ Ottenhoff, T. H. M., Gonzalez, N. M., de Vries, R. R. P., Convit, J. and van Rood, J. J. Association of HLA-LB-E12 (MB1, DC1, MT1) with lepromatous leprosy in a Venezuelan population. *Tissue Antigens* **24** (1984) 25–29.

TABLE 4. *HLA-DR3 is associated with TT leprosy in a Surinam negroid population.*

Individuals	HLA-DR3		RR ^a	χ^2	p
	+	-			
Healthy	49 (23%)	163 (77%)	3.30	9.93	0.002
TT leprosy	16 (50%)	16 (50%)	7.00	10.85	0.001
BL-LL leprosy	4 (11%)	31 (89%)			

^a RR = relative risk which indicates the increased (decreased) chance of an individual carrying the tested antigen to develop disease.

TABLE 5. *HLA-DQw1 is associated with LL leprosy in Venezuela.*

Individuals	HLA-DQw1		RR	χ^2	p
	+	-			
Healthy	13	19	2.7	3.94	0.04
LL leprosy	21	11			

the results from the family study²⁹ as well as several other studies.^{23-26, 30}

In conclusion, the associations between HLA class II alleles and TT as well as BL-LL leprosy are more convincing and consistent than those in the case of class I antigens. Thus, HLA Ir/Is genes for leprosy might map into the class II rather than into the class I region.

HLA and skin-test studies. Besides the studies of association between HLA and leprosy types, a few studies analyzed the influence of HLA antigens on skin-test responses against *M. leprae* and related mycobacteria. One described an increase of DQw1 + (haplotypes) among lepromin-negative leprosy family cases.³¹ Another study reported the absence of DR3 among healthy British individuals who were nonresponders against all mycobacteria tested.³⁴ DR3 was increased albeit not significantly in those individuals who responded against all mycobacteria. DR3 was also associated with high lepromin responsiveness among Ethiopian BT leprosy patients with a history of reversal reactions (Fig. 4) (Ottenhoff, *et al.*, unpublished observations). A fourth study was carried out in Spain, where *M. tuber-*

culosis-specific high responsiveness was associated with HLA-DR4.³⁵

Summary. Family studies have shown that HLA-linked genes presumably do not control susceptibility to leprosy per se, but control—in part—the type of leprosy that may develop upon infection, at least for TT and BL-LL leprosy. Population studies have provided HLA class II markers for leprosy types. Skin-test studies have suggested a role for HLA class II genes in controlling the type of immune response to *M. leprae* and closely related mycobacteria. HLA-DR3 may be a marker for TT leprosy as well as (high) skin-test responsiveness to *M. leprae* antigens and may be a marker for protection against BL-LL leprosy. HLA-DQw1, in contrast, seems to be a marker for BL-LL leprosy as well as *M. leprae* low responsiveness in skin tests.

In vitro studies on the mechanism of HLA class II Ir/Is genes

HLA-DR3 is an Ir gene for *M. leprae* predisposing to TT leprosy. Since the type of leprosy closely correlates with the T-cell-mediated immune response to *M. leprae*, and DR3 seems a marker for TT leprosy as well as (high) responsiveness to *M. leprae*, we wanted to test the hypothesis of whether these associations are due to an HLA-DR3 Ir gene. To this end, we investigated if DR3 molecules might differ from other DR (non3) molecules in the presentation of *M. leprae* and other mycobacteria to Th cells. Th-cell lines and clones, which were CD3+ CD4+

³⁴ van Eden, W., de Vries, R. R. P., Stanford, J. L. and Rook, G. A. W. HLA-DR3 associated genetic control of response to multiple skin tests with new tuberculin. *Clin. Exp. Immunol.* 52 (1983) 287-292.

³⁵ Ottenhoff, T. H. M., Torres, P., Terencio de Las Aguas, J., Fernandez, R., van Eden, W., de Vries, R. R. P. and Stanford, J. L. An HLA-DR4 associated immune response gene for *Mycobacterium tuberculosis*: a clue to the pathogenesis of rheumatoid arthritis? *Lancet* 2 (1986) 310-313.

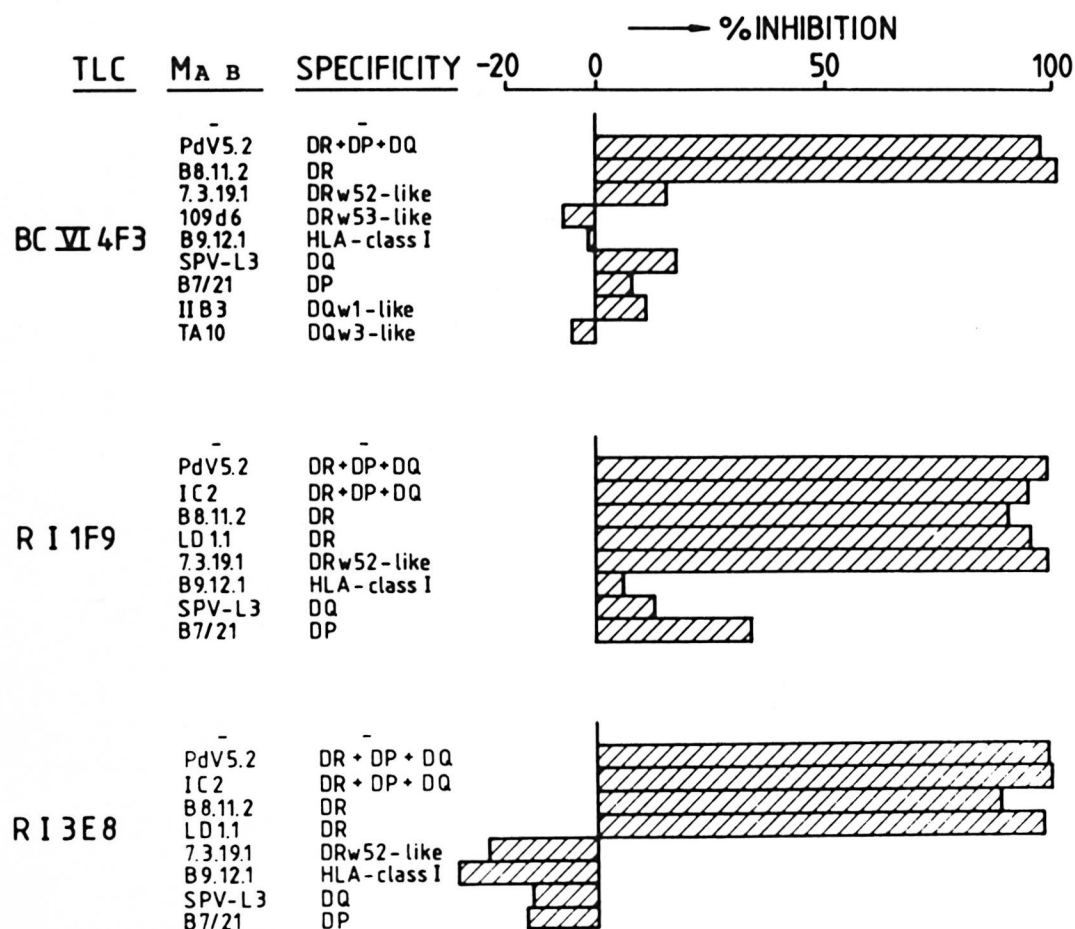

FIG. 5. Localization of restriction determinants for *M. leprae*-reactive T-cell clones (TLC) on HLA-DR molecules as studied by inhibition of T-cell proliferation in the absence or presence of anti-HLA monoclonal antibodies (Mabs).

tissue damage, an essential feature of TT leprosy, may subsequently trigger a (secondary) DR3-specific suppressive signal in order to limit this harmful side effect of the immune response and, thus, may result in the DR3-associated low responsiveness specific for *M. leprae* antigens. In Table 6, the findings of this DR3 Ir gene both *in vivo* and *in vitro* are schematically summarized.

Is HLA-DQw1 associated with an Is gene for *M. leprae*? As discussed above, HLA class II—notably DQw1—linked or associated genes may predispose to the development of BL-LL leprosy as well as to lepromin low responsiveness. Ts cells have been proposed to explain the *M. leprae*-specific

Th unresponsiveness in this form of leprosy. Recently, we have succeeded in cloning Ts cells from a BL patient which specifically suppressed autologous Th-cell responses against mycobacteria but not unrelated antigens.³⁹ One would expect such Ts cells to be regulated by an HLA-DQw1 Is gene. No such Is gene product has been demonstrated convincingly as yet. Interestingly, however, in one study *M. leprae*-specific unresponsiveness, due to suppression, could be abolished with a monoclonal antibody directed against DQw1 molecules (T.

specific delayed type hypersensitivity. *J. Immunol.* **133** (1984) 1594-1600.

³⁹ Ottenhoff, T. H. M., Elferink, D. G., Klaster, P. R. and de Vries, R. R. P. Cloned suppressor T cells from a lepromatous leprosy patient suppress *Mycobacterium leprae* reactive helper T cells. *Nature* **322** (1986) 462-464.

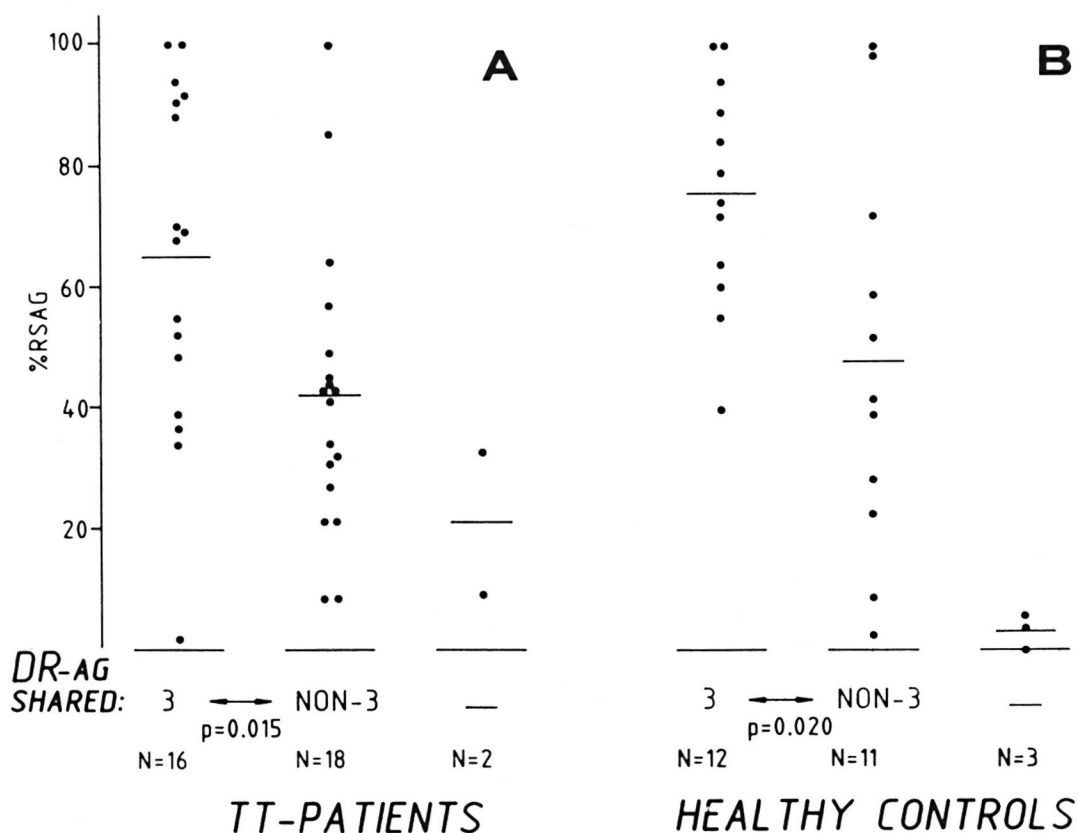

FIG. 6. Preferential HLA-DR3 restriction of PPD-induced proliferation of PPD-selected T-cell lines from 3 TT patients (A) and 3 healthy individuals (B). Results are expressed in % RSAG, i.e., % relative antigen stimulation. The % RSAG is calculated by dividing the proliferative response of a certain T cell-antigen processing cell (APC) combination by the observed proliferation in a standard T cell-APC combination arbitrarily defined as 100%. Such calculations were done only within the same experiment. Mean values for the T cell-APC combination sharing respectively 1 or no DR antigens are indicated by horizontal lines. The significance of the differences of the T-cell responses between these three different groups are indicated.

Sasazuki, personal communication). In Table 7, the results on DQw1 in LL leprosy are summarized.

Clinical modulation of the immune response *in vivo*: fact or fiction?

Leprosy is not the only disease in which HLA class II Ir or Is genes may contribute to the development of clinical disease. A

second example, for instance, is rheumatoid arthritis (RA). RA is associated with HLA-DR4, another class II antigen. DR4 may well be a marker for an HLA class II Ir gene predisposing to RA. The putative antigen(s) triggering the development of RA have remained largely unknown thus far. Recently, however, the results of skin-test studies with different mycobacterial antigens have sug-

TABLE 6. Association of HLA-DR3 with an Ir gene for *M. leprae* antigens.

TT patients	Family studies	Population studies	Skin-test studies	Th cell to <i>M. tuberculosis</i>	Th cell to <i>M. leprae</i>
DR3	++	++	++	++	+
DRnon3	+	+	+	+	++

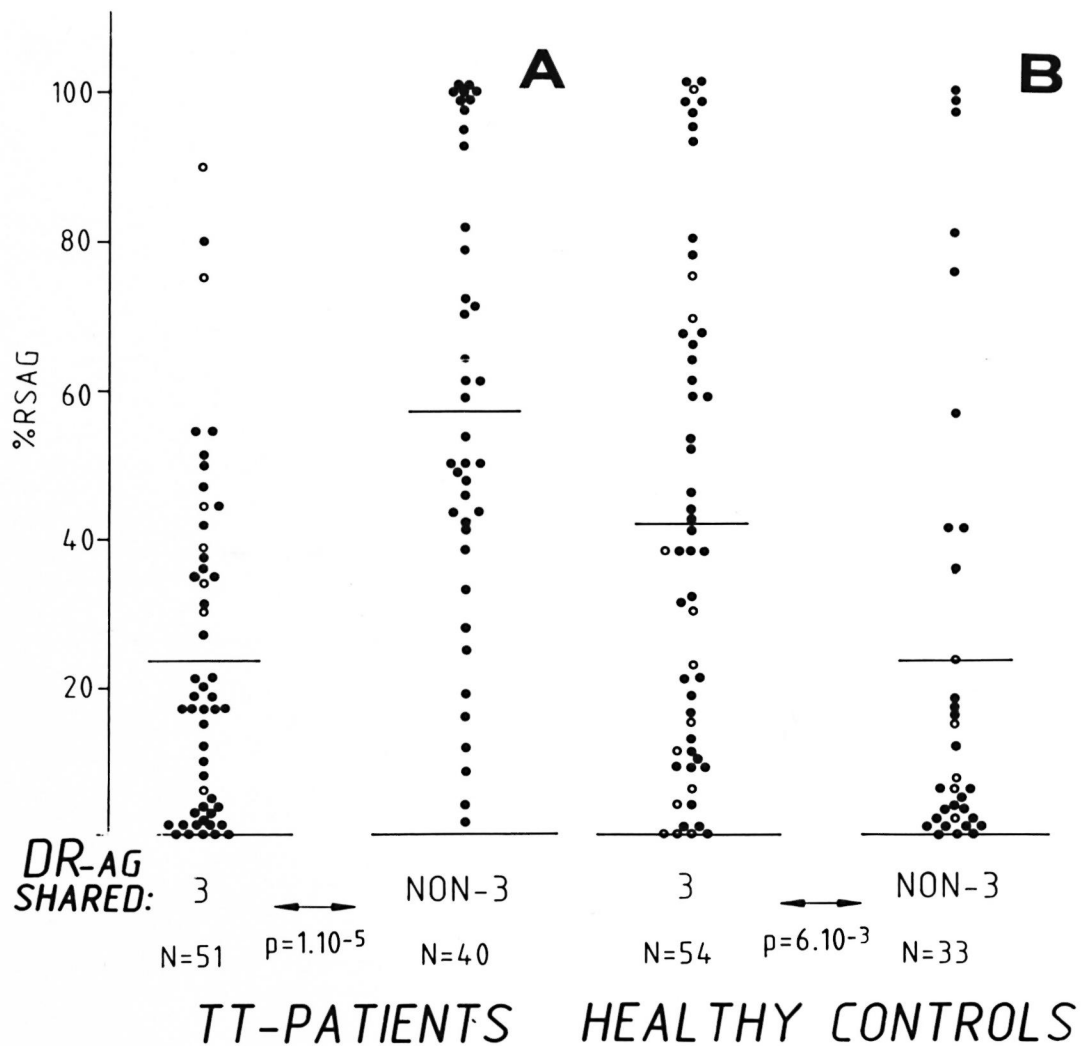

FIG. 7. Preferential HLA-DRnon3 restriction of *M. leprae*-induced proliferation of *M. leprae*-selected T-cell lines from 7 TT patients (A) and preferential HLA-DR3 restriction of proliferation in case of similar T-cell lines from 8 healthy individuals (B). See Figure 5 legend. Open circles in A represent healthy control derived antigen processing cell-patient T-cell combinations; open circles in B, the reverse.

gested that high responsiveness to *M. tuberculosis* but not to other closely related mycobacterial species is associated with HLA-DR4.³⁵ These observations thus sug-

gest that DR4 is associated with Ir genes for RA- and *M. tuberculosis*-specific antigens. The intriguing possibility that one and the same Ir gene is responsible for both of these phenomena was suggested by the finding that in MHC-susceptible rats *M. tuberculosis*-specific T cells could induce a RA-like disease.⁴⁰ Even more interesting is that this rodent model may indeed be extrapolated

TABLE 7. Association of HLA-DQw1 with an *Is* gene for *M. leprae* antigens.

LL patients	Family studies	Population studies	Skin-test low responders	Ts against <i>M. leprae</i>
DQw1	++	++	++	+
DQnon1	+	+	+	+

⁴⁰ Holoshitz, J., Naparstek, Y., Ben-Nun, A. and Cohen, I. R. Lines of T lymphocytes induce or vaccinate against autoimmune arthritis. *Science* **219** (1983) 56-58.

to RA since T cells isolated from affected joints for RA patients have been found to recognize *M. tuberculosis* antigens.⁴¹ The involvement of a class II Ir gene as well as mycobacterial antigen-reactive T cells relevant to the disease imply that RA may be a disease closely related to TT leprosy.⁴² The understanding of the antigenic determinants, T cells, and mechanisms involved in the induction of and protection against these—and other—diseases may lead to rational immunological intervention, resulting in prevention as well as therapy.

One possible target level of immune modulation obviously is the antigen that triggers an immune response. Different regions on antigens have been recognized.⁴³ By comparing, for instance, the antigenic determinants recognized by T cells from healthy individuals as opposed to patients, “protective” antigens may be revealed as well as disease-related epitopes, inducing immunopathology such as in TT or RA.⁴⁴ One example is the finding that cloned T cells, reactive with myelin basic protein and capable of inducing experimental allergic encephalitis in H-2 susceptible mice, all seem to recognize one antigenic determinant.⁴⁵ This determinant was not recognized by non-encephalitogenic T-cell clones. Other disease-related epitopes may induce immunosuppression as occurs in LL.^{39, 46} Vacci-

nation with “protective” epitopes may prevent disease and perhaps even reverse unresponsiveness. Species-specific epitopes might be useful for epidemiological surveys such as skin testing.

A second possible target level of immunomodulation is the blocking of class II Ir or Is epitopes with site-specific monoclonal antibodies (Mabs). The beneficial effects of anti-MHC class II Mab therapy in animals have been reported for several experimental diseases (e.g.,^{47, 48}). A drawback with the systemic use of Mabs against class II backbone determinants, such as HLA-DR-specific Mabs, seems to be the inhibition of immune responsiveness in general when these molecules carry the main restriction determinants for antigen presentation, as is the case for DR (^{37, 49} and Ottenhoff, *et al.*, unpublished observations). In that case, either Mabs specific for disease-related class II epitopes could be used or, alternatively, backbone-specific Mabs may be useful for local intralesional injection, such as in TT or RA. Since HLA-DQ molecules do not seem to be important restriction molecules for Th cells, these drawbacks with systemic use of anti-DR Mabs might not apply to anti-DQ Mabs. Such Mabs, as mentioned above, may reverse the *M. leprae* unresponsiveness in LL patients, presumably by blocking Ts-cell function, analogous to findings in LDH β nonresponder mice which became responsive after anti-I-E^k therapy.⁵⁰ However, since it is not established yet how important DQ molecules are as restriction elements for Ts cells mediating, e.g., tolerance to self antigens, there might also be a

⁴¹ Holoshitz, A., Klajman, A., Drucker, I., Lapidot, Z., Yaretsky, A., Frenkel, A., van Eden, W. and Cohen, I. R. T lymphocytes of rheumatoid arthritis patients show augmented reactivity to a fraction of mycobacteria cross-reactive with cartilage. *Lancet* **2** (1986) 305–310.

⁴² van Rood, J. J. HLA as regulator. *Ann. Rheum. Dis.* **43** (1984) 665–672.

⁴³ Benjamin, D. C., Berzofsky, J. A., East, I. J., Gurd, F. R. N., Hannum, C., Leach, S. J., Margoliash, E., Michael, J. G., Miller, A., Prager, E. M., Reichlin, M., Sercarz, E. E., Smith-Gill, S. J., Todd, P. E. and Wilson, A. C. The antigenic structure of proteins: a reappraisal. *Ann. Rev. Immunol.* **2** (1984) 67–101.

⁴⁴ de Vries, R. R. P., Ottenhoff, T. H. M., Li, S. and Young, R. A. HLA class II restricted helper and suppressor clones reactive with *M. leprae*. *Lepr. Rev.* (in press).

⁴⁵ Zamvil, S. S., Mitchell, D. J., Moore, A. C., Kitamura, K., Steinman, L., and Rothbard, J. B. T-cell epitope of autoantigen myelin basic protein that induces encephalomyelitis. *Nature* **324** (1986) 258–260.

⁴⁶ Bloom, B. R. and Mehra, V. Immunological unresponsiveness in leprosy. *Immunol. Rev.* **86** (1984) 5–28.

⁴⁷ Steinman, L., Rosenbaum, J. T., Sriram, S. and McDevitt, H. O. *In vivo* effects of antibodies to immune response gene products: prevention of experimental allergic encephalitis. *Proc. Natl. Acad. Sci. U.S.A.* **78** (1981) 7111–7114.

⁴⁸ Adelman, N. E., Watling, D. L. and McDevitt, H. O. Treatment of (NZB×NZW) F₁ disease with anti-I-A monoclonal antibodies. *J. Exp. Med.* **158** (1983) 1350–1355.

⁴⁹ Ottenhoff, T. H. M., Elferink, B. G., Hermans, J. and de Vries, R. R. P. HLA class II restriction repertoire of antigen specific T cells. I. The main restriction determinants for antigen presentation are associated with HLA-D/DR and not with DP and DQ. *Human Immunol.* **13** (1985) 105–116.

⁵⁰ Baxevanis, C. N., Ishii, N., Nagy, Z. A. and Klein, J. Role of the E^k molecule in the generation of suppressor T cells in response to LDH β . *Scand. J. Immunol.* **16** (1982) 25–31.

need for "disease-related Is gene epitope" specific DQ Mabs here. In addition, genetically engineered antibodies carrying human Fc parts should be used for *in vivo* therapy to avoid the generation of anti-Fc antibodies neutralizing the Mab.

Thirdly, the *in vivo* activation of antigen-processing cells (APC) with (local) gamma interferon and/or antigen injections may lead to effective APC activation in unresponsive patients, resulting in immune responsiveness. The recent observations on such effects in LL patients render this possibility a new strategy for anergic patients.⁵¹

Antibodies against Th cells have been shown to reverse immunopathological reactions in experimental animal diseases.⁵²⁻⁵⁴ Such antibodies might be useful for the local treatment of TT and RA lesions. An analog for inactivating Ts cells has not been described but can be envisioned once a Ts-specific marker becomes available. Another category of T-cell antibodies would be anti-idiotypic Mabs. Such Mabs can be used to activate Th cells and—perhaps—Ts cells or, alternatively, block such cells. A second type of "idiotypic" therapy may be the use of antigen-specific T cells, as has been reported

for auto-immune arthritis in rats;⁵⁵ whereas certain T-cell clones reactive with *M. tuberculosis* antigens are capable of inducing arthritis (see above), other clones on the other hand could prevent or even cure ongoing arthritis when injected into these rats. Such idiotypic T-cell vaccines may represent an alternative way of preventive and therapeutical immunization.

A lot of questions still remain to be answered before the modes of action of HLA class II Ir and Is genes have been unraveled, in leprosy as well as in other diseases. The studies described here may have helped in solving at least part of the puzzle. The possible applications of the outcome of such studies may contribute to rational and more effective treatment and prevention of HLA class II Ir/Is controlled diseases, such as leprosy.

—Tom H. M. Ottenhoff, M.D., Ph.D.

—Rene R. P. de Vries, M.D., Ph.D.

*Department of Immunohematology and Blood Bank
University Hospital
Leiden, The Netherlands*

Dr. Ottenhoff's present address is Armauer Hansen Research Institute (AHRI), P.O. Box 1005, Addis Ababa, Ethiopia.

⁵¹ Nathan, C. F., Kaplan, G., Levis, W. R., Nusrat, A., Witmer, M. D., Sherwin, S. A., Job, C. K., Horowitz, C. R., Steinman, R. M. and Cohn, Z. A. Local and systemic effects of intradermal recombinant interferon- γ in patients with lepromatous leprosy. *N. Engl. J. Med.* **315** (1986) 6–15.

⁵² Waldor, M. K., Sriram, S., Hardy, R., Herzenberg, L. A., Herzenberg, L. A., Lanier, L., Lim, M. and Steinman, L. Reversal of experimental allergic encephalomyelitis with monoclonal antibody to a T-cell subset marker. *Science* **227** (1985) 415–417.

⁵³ Wofsy, D. and Seaman, W. E. Successful treatment of autoimmunity in NZB/NZW F₁ mice with monoclonal antibody to L3T4. *J. Exp. Med.* **161** (1985) 378–391.

⁵⁴ Titus, R. C., Ceredig, R., Cerottini, J.-C. and Louis, J. A. Therapeutic effect of anti-L3T4 monoclonal antibody GK1.5 on cutaneous leishmaniasis in genetically susceptible BALB/c mice. *J. Immunol.* **135** (1985) 2108–2114.

Acknowledgments. The studies reviewed in this paper received financial support from the Dutch Foundation for Medical Research MEDIGON (grant no. 900-509-099), the Immunology of Leprosy (IMMLEP) component of the UNDP/World Bank/WHO Special Programme for Research and Training in Tropical Diseases, the Netherlands Leprosy Relief Association, and the J. A. Cohen Institute for Radiopathology and Radiation Protection. We wish to thank Dr. Rolf Kiessling and Dr. Paul Converse for critically reading the manuscript, and Mrs. Mulunesh Negash for preparing it.

⁵⁵ Cohen, I. R., Holoshitz, J., van Eden, W. and Frenkel, A. T-lymphocyte clones illuminate pathogenesis and affect therapy of experimental arthritis. *Arthritis Rheum.* **28** (1985) 841–845.